

CONTROLS

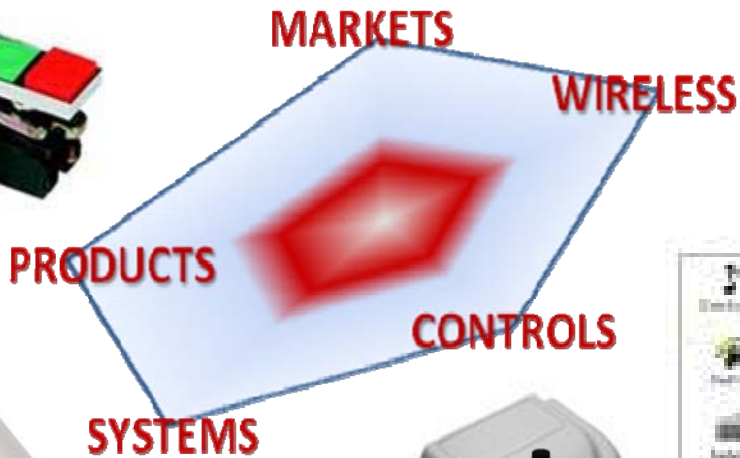

From simple **low cost** switches, to fully **automated**, control loop, smart management systems, & other **input/interface** technologies.



& Software

Off the shelf, IST or custom

computer & Smart Phone

Applications, GUI

Control



RP1



CONTROLS- Buttons/Back Panels

- Push-button, Fascia Panels,
- Membrane Overlays, Other/Virtual
- Face Plates/ Back Panels/ illuminated
- Standard/Customs/ & Your Artwork
- We accept your drawings/designs

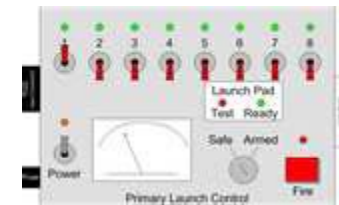

CONTROLS- Automatic

There are many ways to automatically control your systems. By turning your systems on/off to save cost, resources, or even system life.

- **Automatic/Program/Event/Switch/Counts/Random....**
- **Timer/Delay/Day/Light/Clock/Calendar-Scheduler**
- **GPS (PVT-Position/Location, Velocity/Speed, Time/date)**
- **Detector/Sensors (endless, to many to name); level, water, flow, proximity, height, pedestrian, vehicle, speed, direction, wind speed, temperature, humidity, lighting, voltage, current, power, frequency, chemical-bio-nuclear, RFid, beam breaker, oxygen/Co2, and anything needed!!!**

CONTROLS- Pocket Size/One Way

The “Key Fob” RC is one of the cheapest, smallest, low power, short range, wireless control solutions available. Perfect for 1-6 button 600-1000 feet range, where you can still see the device your controlling. Since the RC is “one-way” you have to verify control by visually noticing/indicator/light.

- RC wireless pocket key fob (1-6 button)
- Momentary, Toggle, Latch-1ch ON at a time
- Custom silkscreen, Unique ID, SAW resonator
- Weather Resistant key fob available
- NEMA, Wall Mount available
- Possible to control up to 6 separate devices from only one remote RC key fob



CONTROLS- Simple/ Hand Held

- Simple/small long range 1-3k feet ; Zigbee
- Best Price/Performance, & Networks!!!
- Zigbee 2-way comm handheld (S,M,L) sizes
- Also use as a “repeater”, each device can bounce 2 way communications to another device “transmitter or receiver” or n range
- Hand held's available in NEMA too!
- Up 1-4 button/toggles to a case.
- Hold in hand/battery or Mount.
- Lager box/more battery, AC/solar call



CONTROLS- Advance/ Hand Held

Communications; RC, Zigbee, RF, Bluetooth, wireless or, USB/serial comm.- RS232/485 cable/wired connector) **hand held or panel**

- Also; available in **NEMA** boxes or panels



- 6 button 2x16 LCD display for hand held or panel

- Simple 3 & 5 button 2x16 LCD



CONTROLS- Cell/ Smart Phone

- **Smartphone** is basically a “**Hand Held PC**” computer. With endless features, i/o, etc...
- **Smartphone** custom apps 240x240, 480x,,, 640-800 wide screen resolution, full color.
- Since the device is readily available, and most everyone has one, **downloading control software**, that uses the phone’s features & IST’s ability to control and monitor any device of ours or yours. GPS/Bluetooth/Video/Camera/Wi-Fi/Cell/Text...
- **Free Bluetooth, no cell/fees!!! “unlocked”**



CONTROLS- PC/Laptop/mimi/pcb/chip

- PC/Laptop, Touch Screen, PC104, PLC, programmable relay, embedded-micro chip



- We can scale any application, to a “Micro Chip, control board, harden PC, Touch Screen PC, Smartphone,



- Industrial controller/ PLC,



- Micro Devices, OEM controllers



- Windows Development,

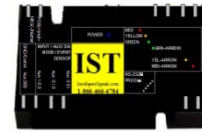

- C+Net, Database, Visual Suite



- **Micro** small to **Macro** big, Scalable!

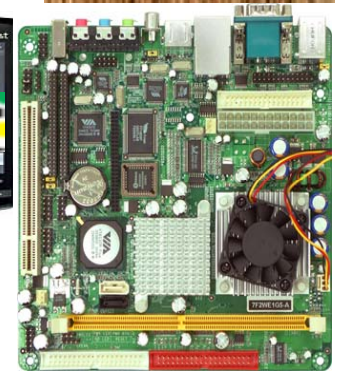

CONTROLS- Multi/Systems

Mix/Combine controls, or above technologies, plug-n-play devices, repeaters, data-ports, Other...



CALL US!!! We will work hand in hand, talk to your departments "Radio" or "IT" group, to give you the best "price & performance" and full service solutions in the industry.

1-866-466-4784

CONTROLS- wire/wireless/protocols

Device to Device, M2M, Computer-Device Etc...
need a method to “Talk” and there are industrial
standards & easy plug-n-play legacy or proprietary.

CALL US!!!

- **Serial RS232/485, USB, Ethernet, Converters & wireless modems, internet- TCP/IP protocols...**
- **Automotive, Transportation, Internet, Wireless**
- **CAN, ISO-9141, NTCIP, POCSAG, ASCII/AT**
- **Wi-Fi 802.11/WiMax 802.16/Ethernet 802.3**
- **PAN/LR-wPAN; 802.15.x Bluetooth, Zigbee/Mesh**
- **IST proprietary protocols for devices/functions**

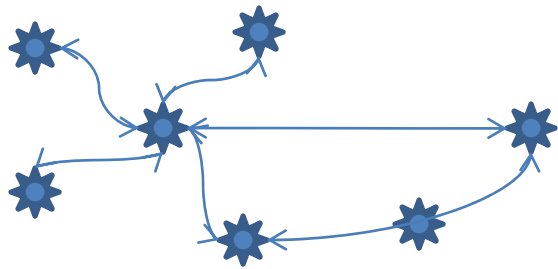

Just add node & function

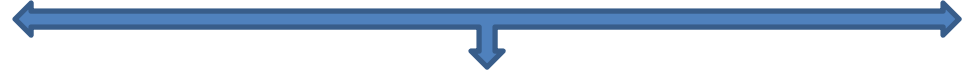

Expansion/Now & Future

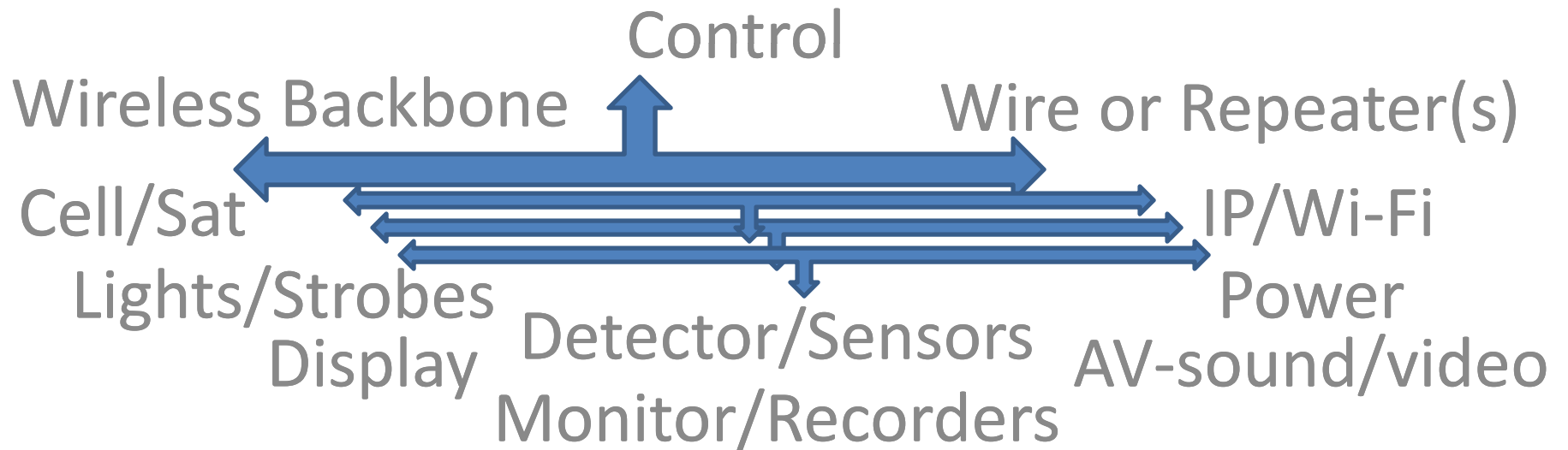

And much more, Customs Etc...

Just add node & function



**USB-GPS, Cell, IrDA
PC-card, Video, I/O, custom
CF flash memory-hard drive**



**Connect wireless off the shelf
USB or PC cards to
IST controllers/Software &
connect to the Internet
or devices you want to
control or monitor wirelessly**

USB
**IRDA Infrared Adapter
WIF-USB-LAN Wi-Fi
Cell/broadband intranet**



**IST
International
SMART
PHONE
APPL...**

